

Name _____

Which One is Different?

Put an X on the one that is different.

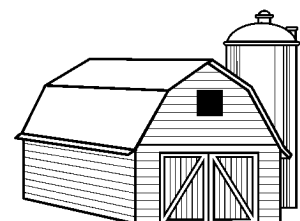
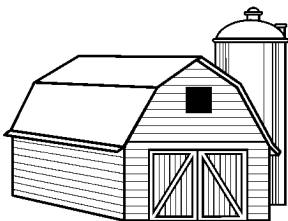
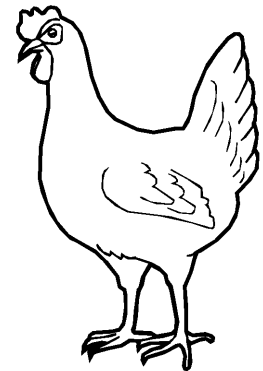
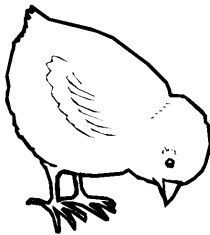
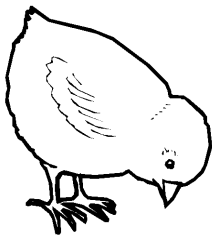
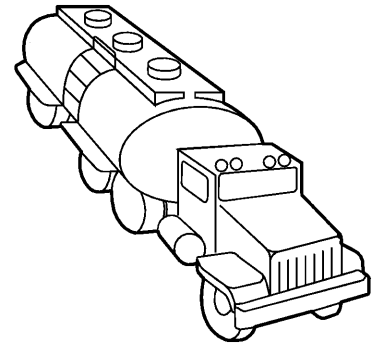
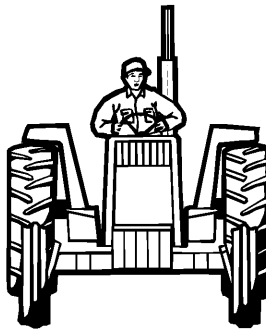
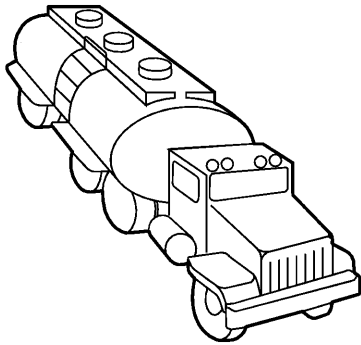
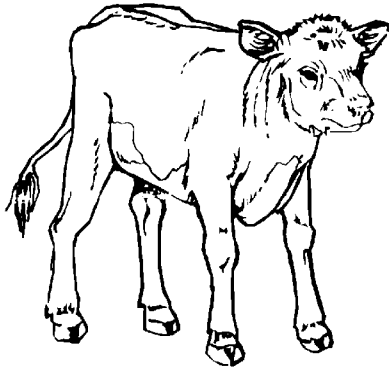

Name _____

Which One is Different?

Put an X on the one that is different

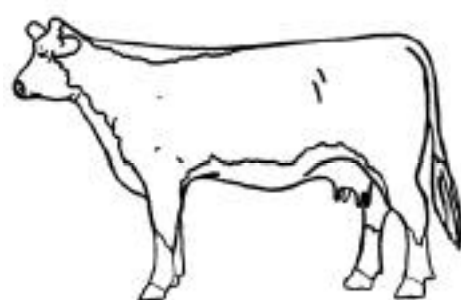
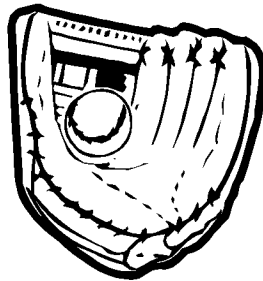
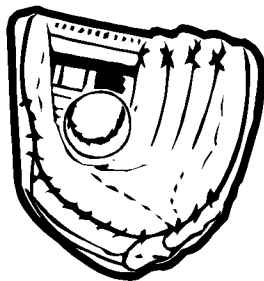
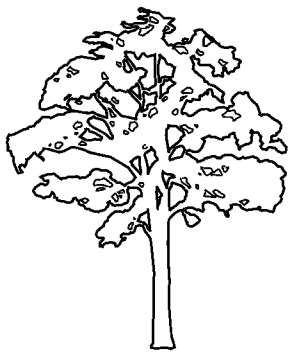
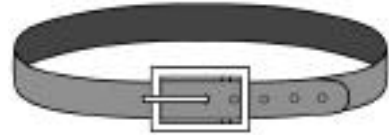
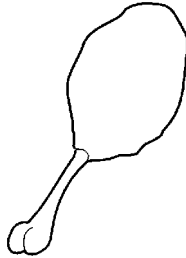
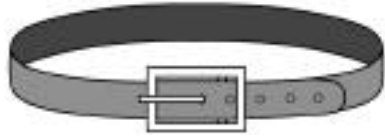

Name _____

Which One is Different?

Put an X on the one that is different.

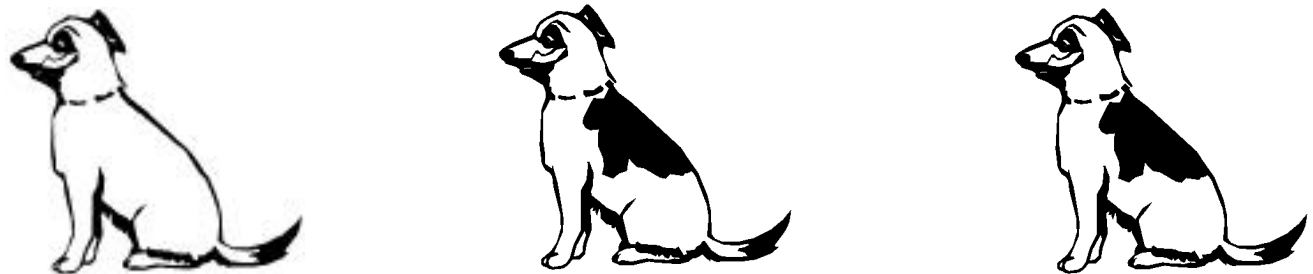
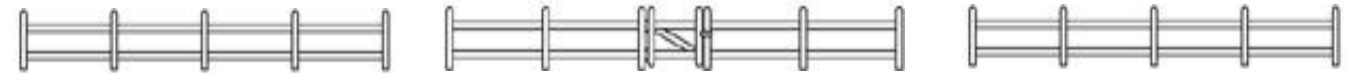
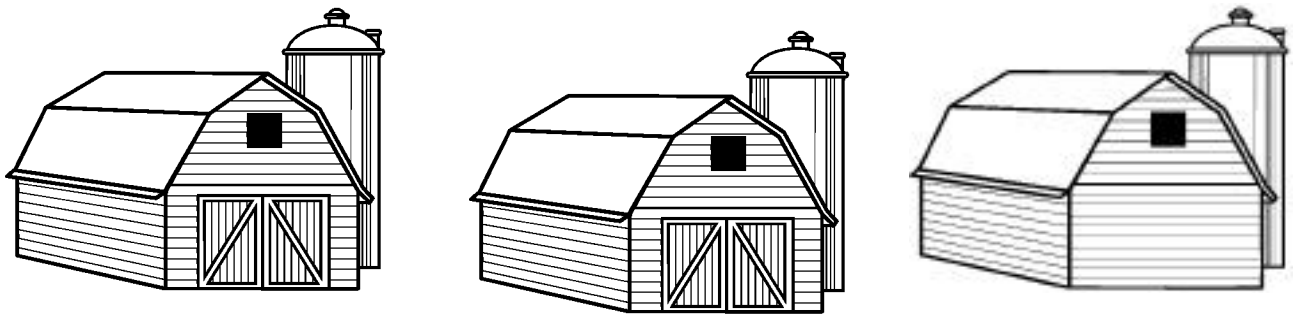
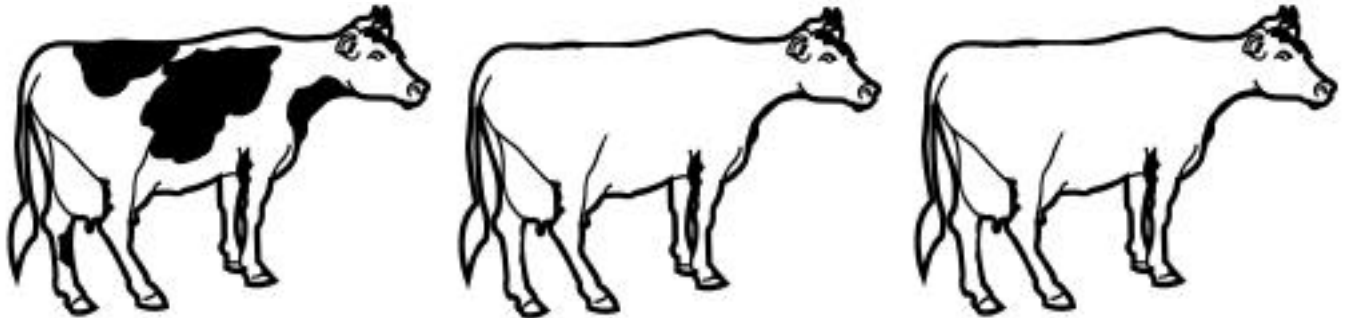

Name _____

Which One is Different?

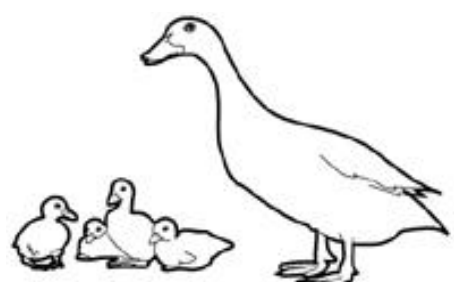
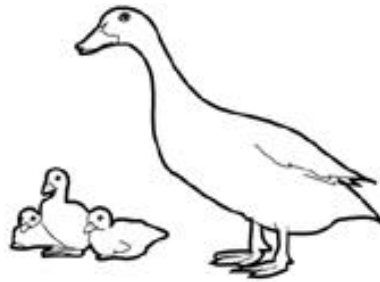
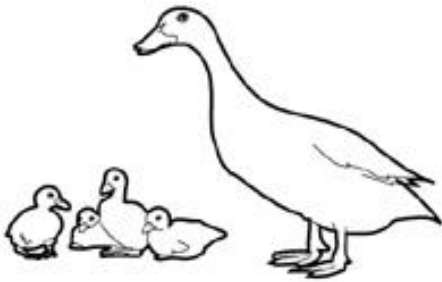
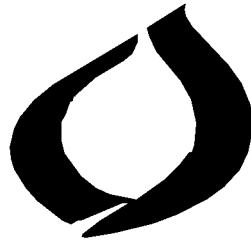

Name _____

Which One is Different?

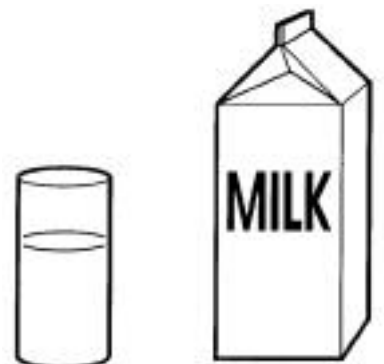
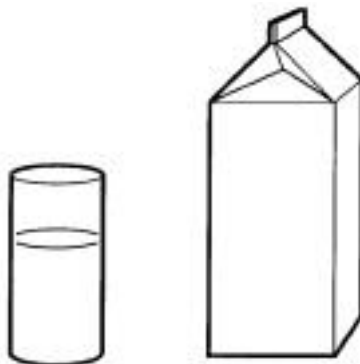
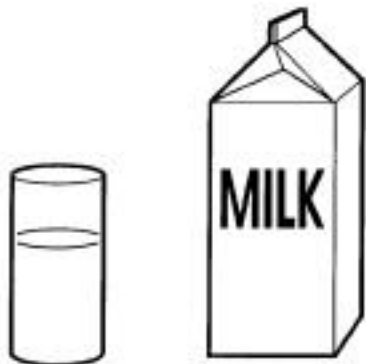
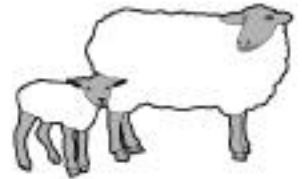
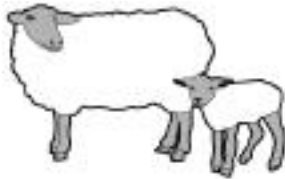
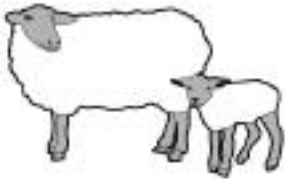
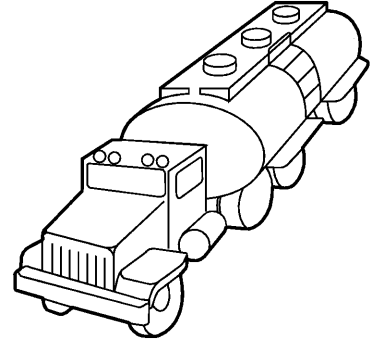
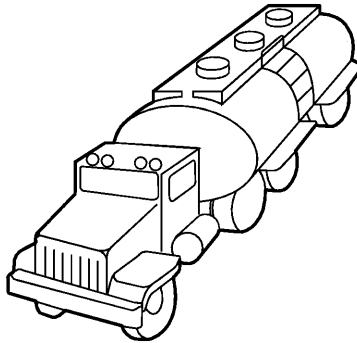
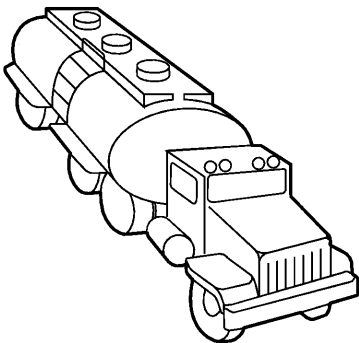
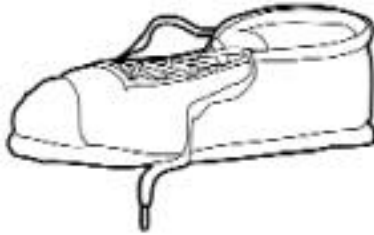
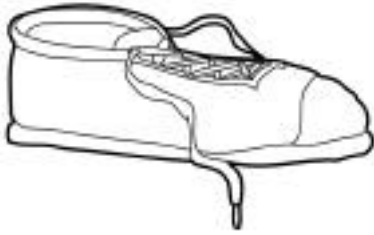

Name _____

Which One is Different

